

dnd

timeless



Dalla collezione Dnd,
una maniglia iconica e
le sue tante, diverse finiture.

*From the Dnd collection,
an iconic door handle and its
many different finishes.*



made in Italy

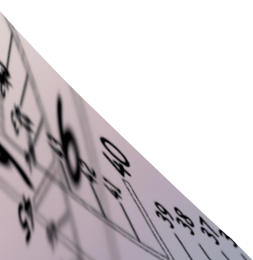

timeless

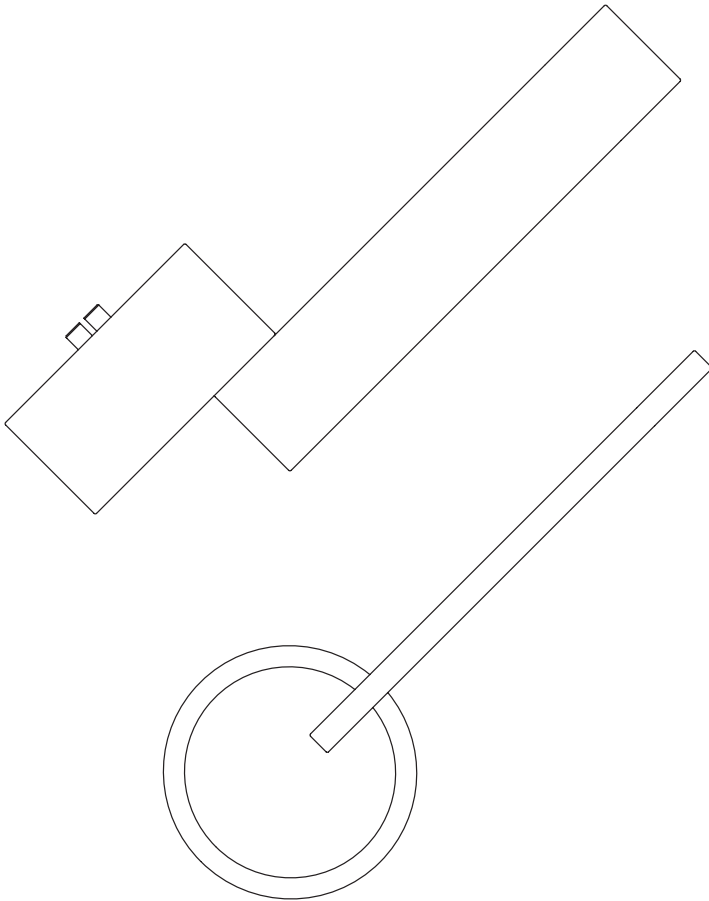

dnd
handles
with care

timeless

Una maniglia che è icona di stile e di tecnologia.

Due segni grafici essenziali, **una linea e un cerchio**, si intersecano in maniera centrale e simmetrica. Il corpo centrale accoglie – e cela – al suo interno il sistema della rosetta e lo trasforma da elemento tecnico a elemento estetico.

Design di Marco Pisati.

A handle that represents an iconic style and technology.

*Two essential graphic elements, **a line and a circle**, that intertwine in a central and symmetric manner. The central body welcomes – and conceals – the backplate system and transforms it from a technical to an aesthetic element.*

Designed by Marco Pisati.







Le finiture:
largo ai progetti!

The finishes:
make way for the designs!

L'ampia palette dei colori della maniglia Timeless è un invito alla personalizzazione e alla creatività nei progetti di interior design.

La versatilità dell'offerta si arricchisce ulteriormente con l'introduzione di **quattro toni inediti**, per un totale di **nove finiture disponibili a catalogo**.

The extensive colour palette of Timeless handles is an invitation to personalization and creativity within interior design projects.

*Versatility is further enhanced with the introduction of **four new shades**, for a total of **nine finishes available**.*



Turchese

Turquoise

Il colore delle acque cristalline del mare.

Vivace e ricercato, il turchese combina la serenità del blu con l'energia del verde.

Un tono che ricorda il tempo dell'estate e comunica raffinata leggerezza.

The colour of the crystal-clear sea.

Lively and sophisticated, turquoise combines the serenity of blue with the energy of green.

A shade reminiscent of summer weather and that conveys elegant lightness.

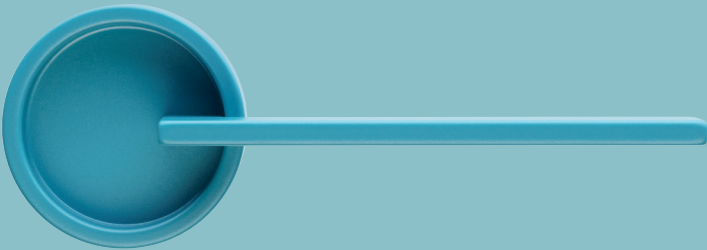
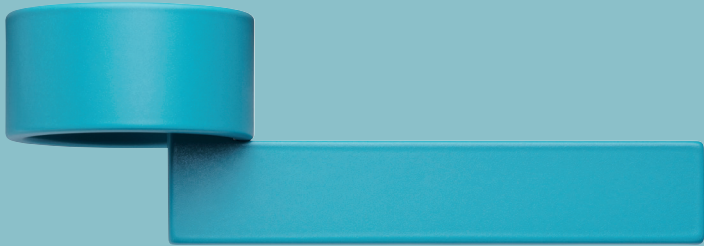

Giallo oliva

Yellow olive

Dal mondo della natura, **una sfumatura molto originale.**

Il giallo oliva, caldo e appagante, rimanda ai toni di elementi materici e del paesaggio toccati dal sole.

A unique shade from the world of nature.

Warm and gratifying, olive yellow is reminiscent of the shades of material elements and sun-kissed landscapes.

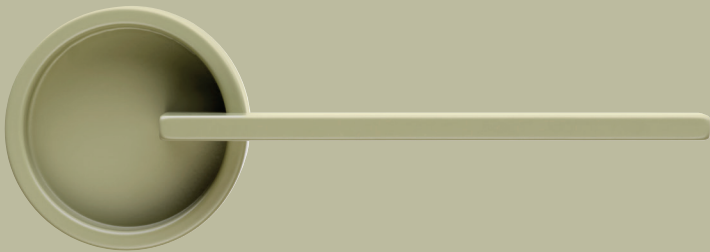

Violetto pastello

Pastel violet

L'eleganza di un fiore, l'unicità del suo colore.

Tra il viola e il bianco, il violetto pastello è una tinta dal carattere romantico e deciso al tempo stesso. **Trasmette serenità ed eleganza.**

The elegance of a flower, the uniqueness of its colour.

*Between purple and white, pastel violet is a shade with a romantic yet decisive character. **It conveys serenity and elegance.***

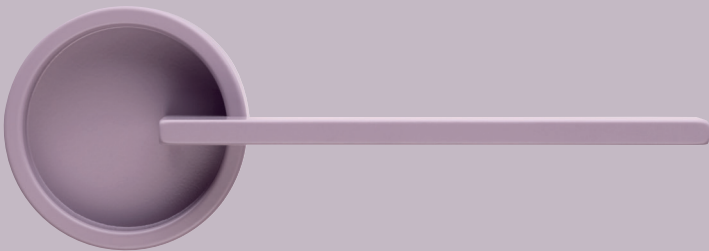

Blu colomba

Dove blue

Una tonalità che sorprende, come una sfumatura inattesa nel cielo.

Il blu colomba conferisce un grande fascino ad arredi e oggetti: **un colore tenue e raffinato**, per valorizzare armonie cromatiche e attenti contrasti.

A tone that surprises, like an unexpected shade of the sky.

*Dove blue conveys great charm to furnishings and objects: **a subtle sophisticated colour** to enhance chromatic harmonies and careful contrasts.*

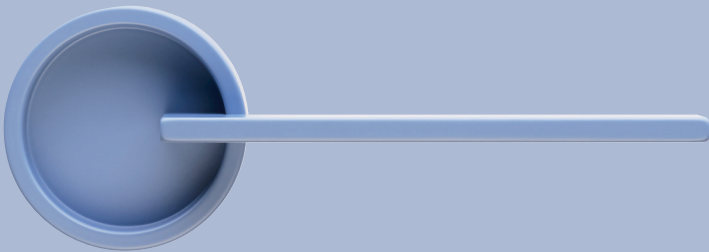

Silver

Silver

Minimale, **leggero e contemporaneo**, come l'oggetto che riveste.

L'argento con effetto satinato è luminoso, versatile e flessibile: un tono applicabile con successo in ogni tipo di ambiente e dal facile dialogo con arredi e complementi della stessa finitura.

*Minimal, **light and contemporary**, just like the object it coats.*

Satin-effect silver is bright, versatile and flexible: the shade works successfully with all kinds of environments and easily dialogues with the furniture and furnishings of the same finish.

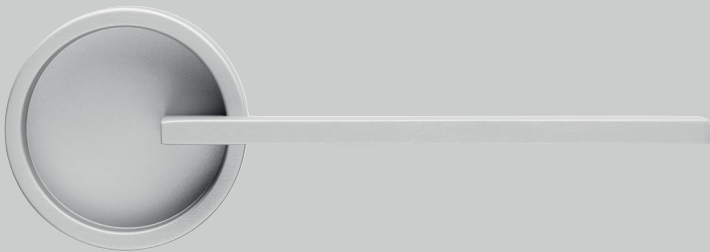

Oro satinato

Satin gold

Raffinato, brillante, luminoso.

L'oro satinato spicca sulla maniglia e sulla superficie della porta, per creare attenti giochi di relazione in ambienti architettonici dal sapore elegantemente eclettico.

Refined, shiny, bright.

Satin gold stands out on handles and door surfaces to create careful combinations in architectural environments with an elegant eclectic flavour.

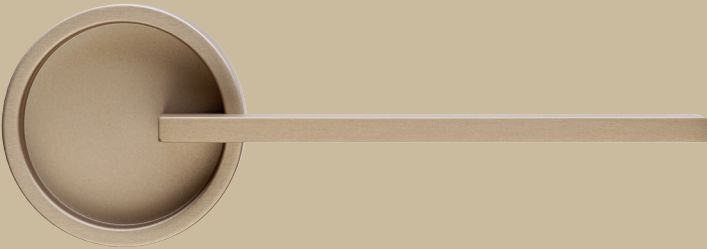

Bronzo

Bronze

Caldo e affascinante, dalla forte personalità.

Il color bronzo segue la tendenza contemporanea che vede le finiture nei toni dei metalli sempre più applicate con successo a complementi, arredi e accessori.

Warm and charming, with a strong personality.

Bronze follows the current trend that sees metal-tone finishes successfully used on furnishings and accessories.

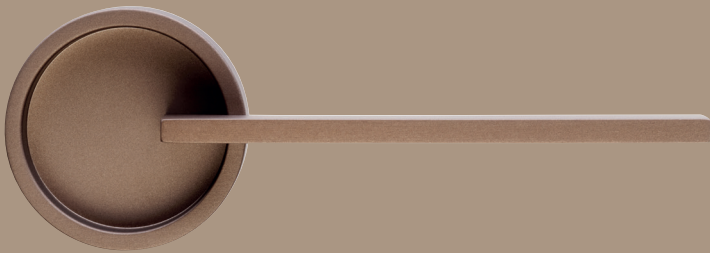

Bianco

White

Dalle molteplici connotazioni, **protagonista con decisione.**

Il colore bianco si declina su superfici dello stesso tono o si impiega per creare contrasti affascinanti e di grande carattere con ogni possibile sfumatura.

A resolved protagonist with multiple connotations.

White is used on surfaces with the same tone or to create fascinating contrasts of great character with any possible hue.

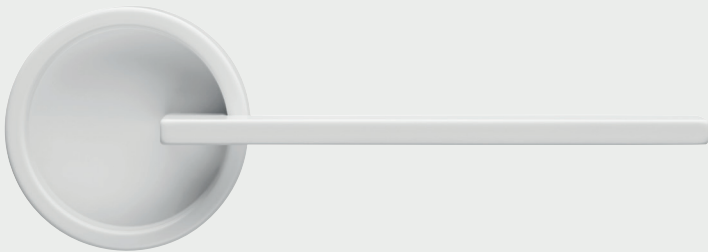

Nero

Black

Come un segno rigoroso e distintivo.

Il nero definisce e fa emergere la maniglia con raffinata decisione, in spazi dal sapore contemporaneo e caratterizzati da una puntuale attenzione al progetto.

Like a rigorous distinctive mark.

Black defines and makes handles stand out with elegant determination in environments with a contemporary flavour characterized by accurate attention to design.

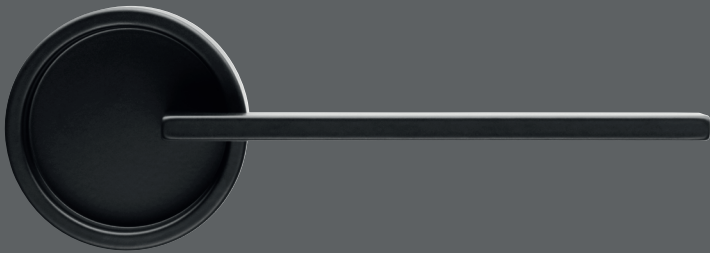

ANE

Alluminio
Aluminium



ABT new
Turchese
Turquoise



AGO new
Giallo oliva
Yellow olive



AVP new
Violetto pastello
Pastel violet



ABC new
Blu colomba
Dove blue



ASV
Silver
Silver



ARO
Oro satinato
Satin gold



ABR
Bronzo
Bronze



ABN
Bianco
White



ANE
Nero
Black

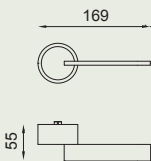

Maniglia
Handle

FINE TL01



Pomolo
Knob

FINE TL40 - set
TL39 - single



Pomolino per mobili
Knob for furniture

TL70

Marco Pisati



Designer fiorentino, architetto di formazione, è affascinato dai nuovi materiali e dalle nuove tecnologie. Sperimenta le sue idee nei settori più diversi, progettando per diverse aziende: ASI (Agenzia Spaziale Italiana), Emilio Pucci, Antonio Lupi, Cordivari, Cristina Rubinetterie, Gattoni Rubinetterie, Treemme Rubinetterie, Glass Design, K8 Radiatori. Diversi i premi e i riconoscimenti ottenuti dai suoi prodotti: Red Dot Design Award, German Design Award, Archiproducts Design Award, ADI Ceramics & Bathroom Design Award.

A designer from Florence, trained as an architect, fascinated by new materials and technologies. He experiments with ideas in a wide range of sectors, designing for different companies: ASI (Italian Space Agency), Emilio Pucci, Antonio Lupi, Cordivari, Cristina Rubinetterie, Gattoni Rubinetterie, Treemme Rubinetterie, Glass Design, K8 Radiatori. He has been awarded many design awards for his projects: Red Dot Design Award, German Design Award, Archiproducts Design Award, ADI Ceramics & Bathroom Design Award.

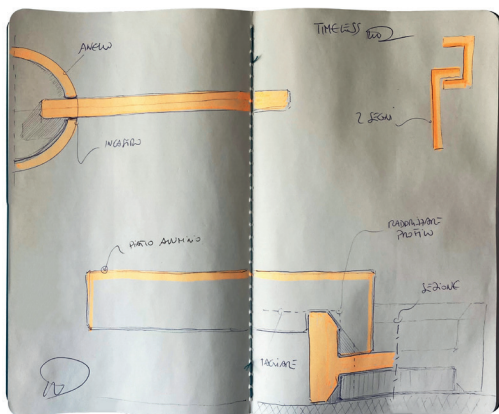

timeless

Disegni della maniglia di
Handle sketches by
Marco Pisati

Copertina /

Cover

Leonardo Sonnoli

Irene Bacchi

- Studio Sonnoli -

Fotografie

delle maniglie /

Door handles

photographs

Tiziano Reguzzi



Dnd Martinelli S.r.l.

Località Piani di Mura, 2
25070 Casto (BS) - Italia

T +39 0365 899113

info@dndhandles.it

www.dndhandles.it



© 2022 Dnd Martinelli S.r.l.

Tutti i diritti riservati

All rights reserved

dnd

**handles
with care**

dndhandles.it

Dnd Martinelli S.r.l.

Località Piani di Mura, 2
25070 Casto (BS) - Italia

T +39 0365 899113
info@dndhandles.it

www.dndhandles.it

