

dnd

**design focus
2019**



04 boole

Odo Fioravanti

12 zeppelin

Jaime Hayon

20 ginkgo

Giulio Iacchetti

32 timeless

Marco Pisati

40 madeleine

Inga Sempé

dnd

design focus
2019

Dnd mette la **sapienza produttiva al servizio della migliore creatività**, coinvolgendo progettisti di valore per focalizzare l'attenzione verso il mondo del design, arricchire la gamma dei prodotti, soddisfare al meglio la progettazione degli interni contemporanei: **Odoardo Fioravanti, Jaime Hayon, Giulio Iacchetti, Marco Pisati e Inga Sempé** hanno disegnato maniglie in cui sono evidenti la ricerca e la qualità del progetto.

*Dnd puts **productive know-how at the service of remarkable creativity**, involving outstanding designers in a focus on style and functional quality, expanding the range of products to adapt to the evolution of the world of contemporary interiors: **Odoardo Fioravanti, Jaime Hayon, Giulio Iacchetti, Marco Pisati and Inga Sempé** have created handles that clearly reflect in-depth research and the pursuit of design quality.*

Dal 1968, tra sapienza artigianale e innovazione. Un'azienda che oggi è punto di riferimento internazionale per la produzione di **maniglie che guardano alla qualità e al progetto**. La storia di Dnd nasce dall'antica e spiccata **dedizione artigianale e industriale** diffusa nella Val Sabbia, in provincia di Brescia. Un territorio con un sapere materiale centenario, soprattutto a vocazione siderurgica – tra i maggiori poli europei del settore: qui, a Nozza, nasceva nel 1968 l'azienda FMN Martinelli sotto la guida di Angelo Martinelli, uomo capace e appassionato produttore di maniglie, pomoli e battenti di alta qualità. Nel tempo, l'azienda si è evoluta e si è concentrata sullo sviluppo e sull'incremento della produzione, rinnovando i processi produttivi e specializzandosi nella lavorazione e nella rifinitura dei nuovi e diversi metalli destinati alla produzione delle maniglie, come la zama e l'alluminio, oltre naturalmente all'ottone. Oggi, con il nome Dnd, l'azienda è diretta da Vilma Martinelli insieme ai figli Pietro e Simona, che da anni sono importanti figure di riferimento e di affiancamento: il loro impegno ambizioso è quello di dar vita a una **fucina di idee**, coniugando la lunga esperienza produttiva acquisita con la **creatività di architetti e designer di valore** che vengono puntualmente coinvolti nel disegno dei prodotti. Progettisti, artigiani e fornitori sono parte attiva e preziosa dell'anima di Dnd, che da storica fucina produttiva guarda al presente e al futuro con fiducia: una **solida vocazione aziendale – e territoriale – al servizio del progetto contemporaneo, italiano e internazionale**.

*Since 1968, combining fine craftsmanship and innovation. A company that is now an international reference point for the production of **handles with a focus on high quality and good design**. The Dnd story stems from the **remarkable tradition of craftsmanship** throughout Val Sabbia, in the province of Brescia. A territory with an age-old material culture, above all in the production of steel, as one of the major European centers for this sector. In this region, at Nozza, the company FMN Martinelli was founded in 1968 under the leadership of Angelo Martinelli, an expert on the production of handles, knobs and knockers of the highest quality. The firm has evolved over time, concentrating on production growth, updating manufacturing processes and specializing in the use and finishing of various metals for the production of handles, including zamak and aluminium as well as brass. Today, with the name Dnd the company is helmed by Vilma Martinelli together with her children Pietro and Simona, who have been important figures of reference and support for years now: their ambitious goal is to make Dnd a **hotbed of ideas**, combining extensive production experience with the **creativity of exceptional architects and designers** selected to create particular products. Designers, craftsmen and suppliers are seen as precious, active resources for Dnd, which relying on its history of industrial know-how can look to the present and the future with confidence: as a **solid corporate – and territorial – resource at the service of Italian and international contemporary design**.*

Odo Fioravanti



È un industrial designer con base a Milano. Nel 2011 ha vinto il Premio Compasso d'Oro ADI con la sedia Frida. Tra i suoi clienti, Flou, Fontana Arte, Foscarini, Land Rover, Normann Copenhagen, Pedrali, Toshiba, Vibram, Victorinox.

He is a Milan based industrial designer. In 2011, he won the Compasso d'Oro ADI award for the Frida chair. Among his clients, Flou, Fontana Arte, Foscarini, Land Rover, Normann Copenhagen, Pedrali, Toshiba, Vibram, Victorinox.



1.



2.

1. Galileo, Palomar (2009) – 2. Freeride, Land Rover (2016) – 3. Bern clutch, Maison203 (2017) – 4. Frida, Pedrali (2008)
5. Bliss, Normann Copenhagen (2017) – 6. Nello, Palomar (2015) – 7. Volée, Fontana.Arte (2016)



3.



4.



5.



6.



7.

boole

design:
Odo Fioravanti

Due cilindri si incontrano e si intersecano con il leggero slittamento di uno rispetto all'altro, nella condivisione di una piccola, comune porzione di materia.

Boole è disponibile in tre finiture:
cromo lucido, cromo satinato, nero.

Two cylinders meet and intersect with a slight shift, sharing a small portion of material.

*Boole is available in three different finishes:
polished chrome, satin chrome, black.*



boole

design:
Odo Fioravanti





boole

**design:
Odo Fioravanti**



BE40
OC

010-

dnd design focus 2019

Ottone stampato a caldo
Hot stamped brass



OC
Power cromo lucido
Power polished chrome



PCS
Power cromo satinato
Power satin chrome



ONO
Nero
Black

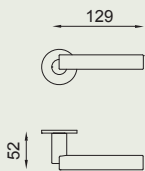

VIS BE12

FINE BE40

VIS BE22V

🔒 BE22TS

Jaime Hayon



Artista-designer originario di Madrid, ha aperto il suo studio a Valencia nel 2010. Con uffici in Spagna, Italia e Giappone, progetta per Fritz Hansen, Bosa, Cassina, BD Barcellona, Wittmann, Magis, Ceccotti, &Tradition, Baccarat, Paola C, Bisazza, Lladro, Vicarbe, Arflex, Nani Marquina, Vista Alegre, Parachilna.

Artist-designer originally from Madrid, opened his studio in Valencia in 2010. With offices in Spain, Italy and Japan, he designs for Fritz Hansen, Bosa, Cassina, BD Barcelona, Wittmann, Magis, Ceccotti, &Tradition, Baccarat, Paola C, Bisazza, Lladro, Vicarbe, Arflex, Nani Marquina, Vista Alegre, Parachilna.



1.



2.

1. 2. La Terraza del Casino, Madrid (2018) Ph. KlunderBie – 3. Grid, Gaia & Gino (2008) – 4. Aballs Lamps, Parachilna (2013)
5. Camper shop, Tokyo (2009) – 6. Hayon Tiles Collection, Bisazza (2014) – 7. Showtime Nude, BD Barcelona Design (2017)



3.



4.



6.



5.



7.

zeppelin

design:
Jaime Hayon

Volumi marcati e arrotondati come rimando formale – e decorativo – ai dirigibili Zeppelin dell'inizio del 1900, per una maniglia contemporanea, dalla sapiente realizzazione tecnica.

Zeppelin è disponibile in quattro finiture: nero, verde, nickel lucido, oro antico lucido.

Pronounced rounded volumes as a formal – and decorative – reference to the Zeppelin airships of the early 1900s, for a contemporary handle made with great technical prowess.

Zeppelin is available in four different finishes: black, green, polished nickel, antique bright gold.



zeppelin

**design:
Jaime Hayon**





zeppelin

**design:
Jaime Hayon**



ZP12
ONV

018-

dnd design focus 2019

Ottone stampato a caldo
Hot stamped brass



ONO
Nero
Black



OVE
Verde
Green



ONV
Nickel lucido
Polished nickel



PVD-BG
PVD oro antico lucido
Antique bright gold PVD

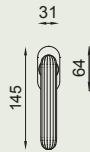
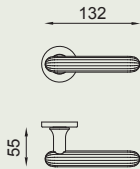

VIS ZP12

VIS ZP22V

 ZP22TS

Giulio Iacchetti



Con base a Milano, si occupa di industrial design dal 1992. Tra le aziende con cui collabora, Abet Laminati, Alessi, Danese, Foscarini, Magis, Meritalia, Moleskine, Montini. Nel 2012 lancia il marchio Internoitaliano. Nel maggio 2009 la Triennale di Milano ha ospitato una sua mostra personale intitolata "Giulio Iacchetti. Oggetti disobbedienti". È stato premiato con due premi Compasso d'Oro (2001 e 2014).

Based in Milan, he is an industrial designer since 1992. Among the companies he works with, Abet Laminati, Alessi, Danese, Foscarini, Magis, Meritalia, Moleskine, Montini. In 2012 he launches the brand Internoitaliano. In May 2009 the Milan Triennale held a solo exhibition titled "Giulio Iacchetti. Disobedient objects." He was awarded two Compasso d'Oro (2001 and 2014).



1.



2.



3.

1. Classic Collection, Moleskine (2017) – 2. Affi, Internoitaliano (2012) – 3. Moscardino, Pandora Design (2000)
4. Ora In /Ora Out, Alessi (2015) – 5. Tancredi e Bartolomeo, De Vecchi Milano 1935 (2012) – 6. Olmo, Artemide (2015)
7. Surf-o-Morph, Surfer's Den (2014) – 8. Magneto, Foscarini (2012)



4.

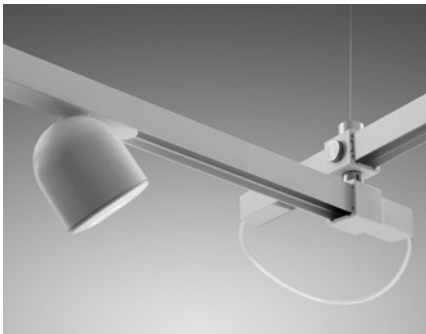

6.

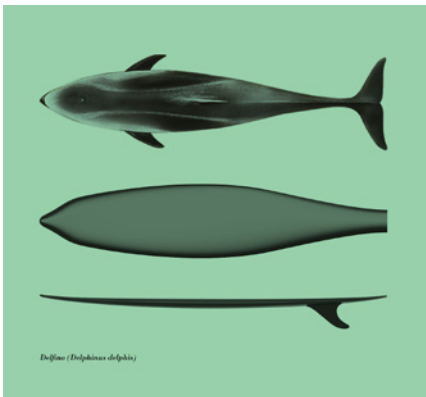

7.



5.

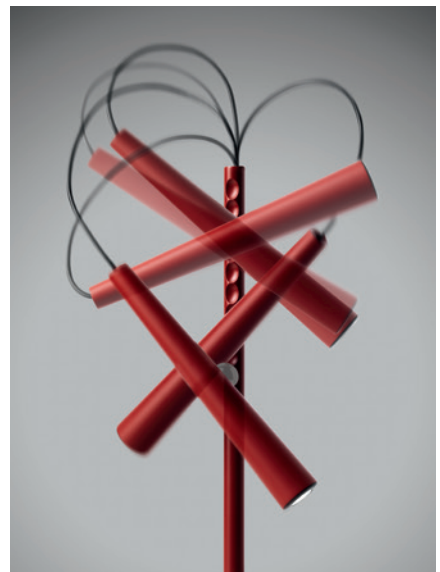

8.

ginkgo / ginkgo biloba

design:
Giulio Iacchetti

Una forma di ispirazione naturale, quale la bellissima foglia del Ginkgo, si fa struttura e decoro per una maniglia che nasce in due diverse versioni.

Ginkgo è disponibile in sei finiture: cromo lucido, cromo satinato, nickel lucido, grafite satinato, oro antico lucido, oro antico satinato.

A form based on nature, the special, unique shape of a Ginkgo leaf, becomes the structure and decoration of a handle that is made in two different versions.

Ginkgo is available in six different finishes: polished chrome, satin chrome, polished nickel, satin graphite, antique bright gold, antique satin gold.



ginkgo biloba

**design:
Giulio lacchetti**



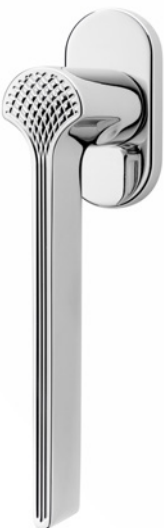
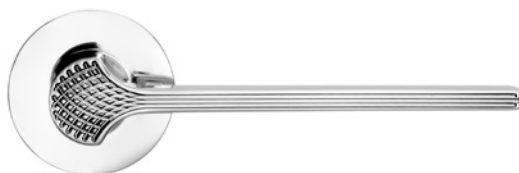

ginkgo biloba

**design:
Giulio lacchetti**



GB40
OC

026-

dnd design focus 2019

Ottone stampato a caldo
Hot stamped brass



OC
Power cromo lucido
Power polished chrome



PCS
Power cromo satinato
Power satin chrome



ONV
Nickel lucido
Polished nickel



PGS
PVD grafite satinato
Satin graphite PVD



PVD-BG
PVD oro antico lucido
Antique bright gold PVD



PVD-SG
PVD oro antico satinato
Antique satin gold PVD

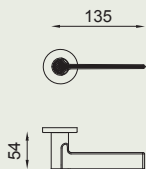

**Good Design Awards
2017**

VIS GB12

FINE GB40

VIS GB22V

LOCK GB22TS

ginkgo

**design:
Giulio lacchetti**





ginkgo

design:
Giulio lacchetti



GK40
PCS

030-

dnd design focus 2019

Ottone stampato a caldo
Hot stamped brass



OC
Power cromo lucido
Power polished chrome



PCS
Power cromo satinato
Power satin chrome



ONV
Nickel lucido
Polished nickel



PGS
PVD grafite satinato
Satin graphite PVD



PVD-BG
PVD oro antico lucido
Antique bright gold PVD



PVD-SG
PVD oro antico satinato
Antique satin gold PVD

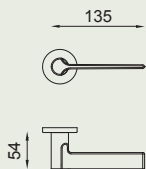

**Good Design Awards
2017**

VIS GK12

FINE GK40

VIS GK22V

LOCK GK22TS

Marco Pisati



Designer fiorentino, architetto di formazione, è affascinato dai nuovi materiali e dalle nuove tecnologie. Sperimenta le sue idee nei settori più diversi, progettando per diverse aziende: ASI, Emilio Pucci, Antonio Lupi, Cordivari, Treemme Rubinetterie, Glass Design, Gattoni Rubinetterie, K8.

A designer from Florence, trained as an architect, fascinated by new materials and technologies. He experiments with ideas in a wide range of sectors, designing for different companies:

ASI, Emilio Pucci, Antonio Lupi, Cordivari, Treemme Rubinetterie, Glass Design, Gattoni Rubinetterie, K8.



1.



2.

1. 2. Decò, Kerasan (2016) – 3. 4. Iride, Antonio Lupi (2017) – 5. Ran, Treemme (2015) – 6. Lumen, Antonio Lupi (2018)
7. Lynea, Cordivari (2017)



3.

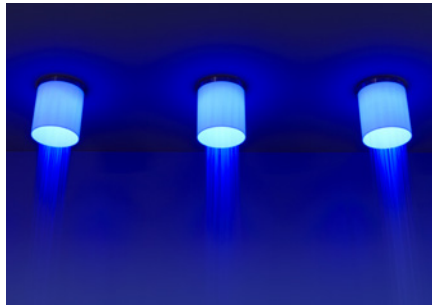

4.



5.



6.



7.

timeless

design:
Marco Pisati

Due segni grafici essenziali, una linea e un cerchio che si intersecano in maniera centrale e simmetrica.

Timeless è disponibile in cinque finiture: silver, oro satinato, bronzo, bianco, nero.

Two essential graphic signs, a line and a circle that intersect in a central and symmetrical way.

Timeless is available in five different finishes: silver, satin gold, bronze, white, black.



timeless

**design:
Marco Pisati**



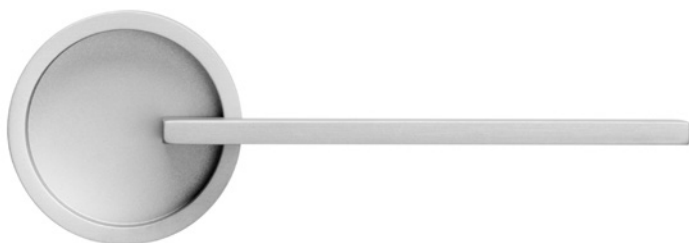
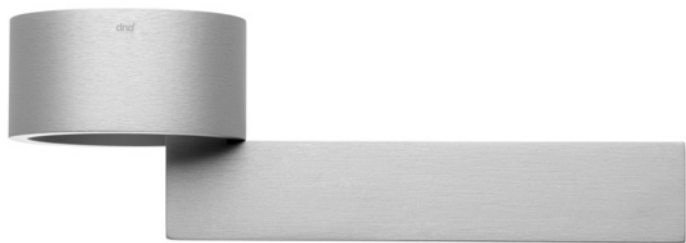

timeless

design:
Marco Pisati

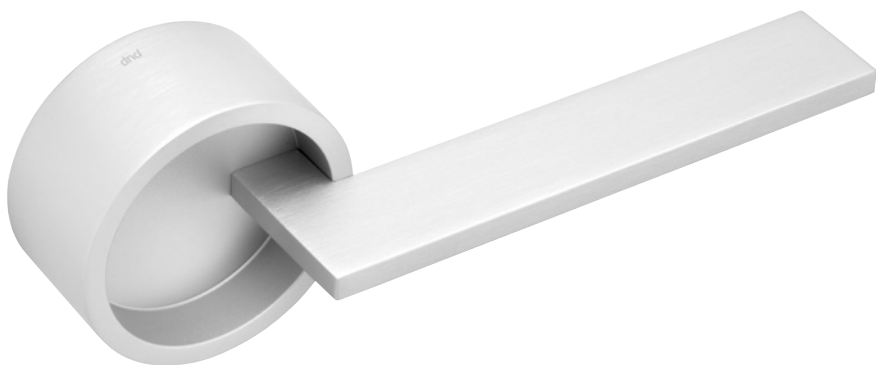

TL01
ASV

038-

dnd design focus 2019

Alluminio
Aluminium



ASV
Silver
Silver



ARO
Oro satinato
Satin gold



ABR
Bronzo
Bronze



ABN
Bianco
White



ANE
Nero
Black

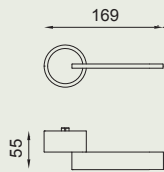

FINE TL01



FINE TL40 - SET
TL39 - SINGOLO

Inga Sempé



Nata a Parigi, ha aperto il suo studio parigino nel 2000. Le sue prime collaborazioni sono state con Edra e Cappellini. Oggi lavora con diverse aziende francesi, scandinave e italiane, tra le quali HAY, Magis, Ligne Roset, Wästberg, Alessi, LucePlan, Mutina, Mattiazzi.

Parisian born designer, she opened her own studio in 2000, in Paris. In the beginning, she first collaborated with Edra and Cappellini. Today, she works with Scandinavian, Italian and French companies such as HAY, Magis, Ligne Roset, Wästberg, Alessi, LucePlan, Mutina, Mattiazzi.



1.

1. Ruché, Ligne Roset (2010) – 2. Sempé w153, Wästberg (2015) – 3. Lampes, Moustache (2012) – 4. Collo-alto, Alessi (2015)
5. Meteo, Golran (2015) – 6. Herringbone, Crane (2017)



2.



3.



5.



4.



6.

madeleine

design:
Inga Sempé

Un omaggio alla dolce madeleine d'oltralpe in una piccola maniglia decorata che ne riprende la forma a conchiglia.

Madeleine è disponibile in tre finiture: nero, nickel lucido, oro antico lucido.

A tribute to the famous madeleine cakes from beyond the Alps, in a small decorated handle that replicates their seashell form.

Madeleine is available in four different finishes: black, polished nickel, antique bright gold.



madeleine

**design:
Inga Sempé**

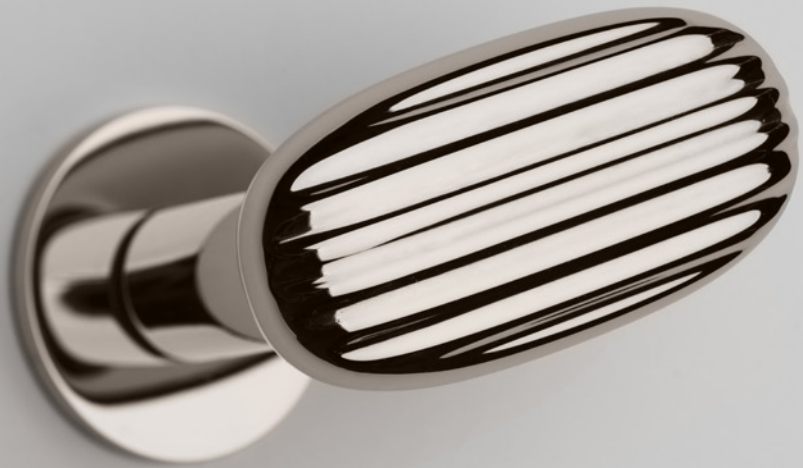

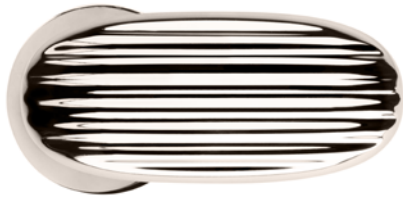

madeleine

**design:
Inga Sempé**



MA40
PVD-BG

046-

dnd design focus 2019

Ottone stampato a caldo
Hot stamped brass



ONO
Nero
Black



ONV
Nickel lucido
Polished nickel



PVD-BG
PVD oro antico lucido
Antique bright gold PVD



VIS MA12

FINE MA40

VIS MA22V

LOCK MA22TS

Copertina /
Cover
studio Leonardo Sonnoli

Fotografie
delle maniglie /
Door handles
photographs
Tiziano Reguzzi

Grazie a /
Thanks to
Odo Fioravanti
Jaime Hayon
Giulio Iacchetti
Marco Pisati
Inga Sempé

Dnd Martinelli S.r.l.
Località Piani di Mura, 2
25070 Casto (BS) – Italia

© 2019 Dnd Martinelli S.r.l.

Modelli e marchi depositati.
Tutti i diritti riservati.
Registered trademarks
and patented designs.
All rights reserved.

Dnd
Località Piani di Mura, 2
25070 Casto (BS) – Italia

T +39 0365 899113
F +39 0365 899118

www.dndhandles.it



dnd

**handles
with care**

dndhandles.it

Odo Fioravanti
Jaime Hayon
Giulio Iacchetti
Marco Pisati
Inga Sempé